

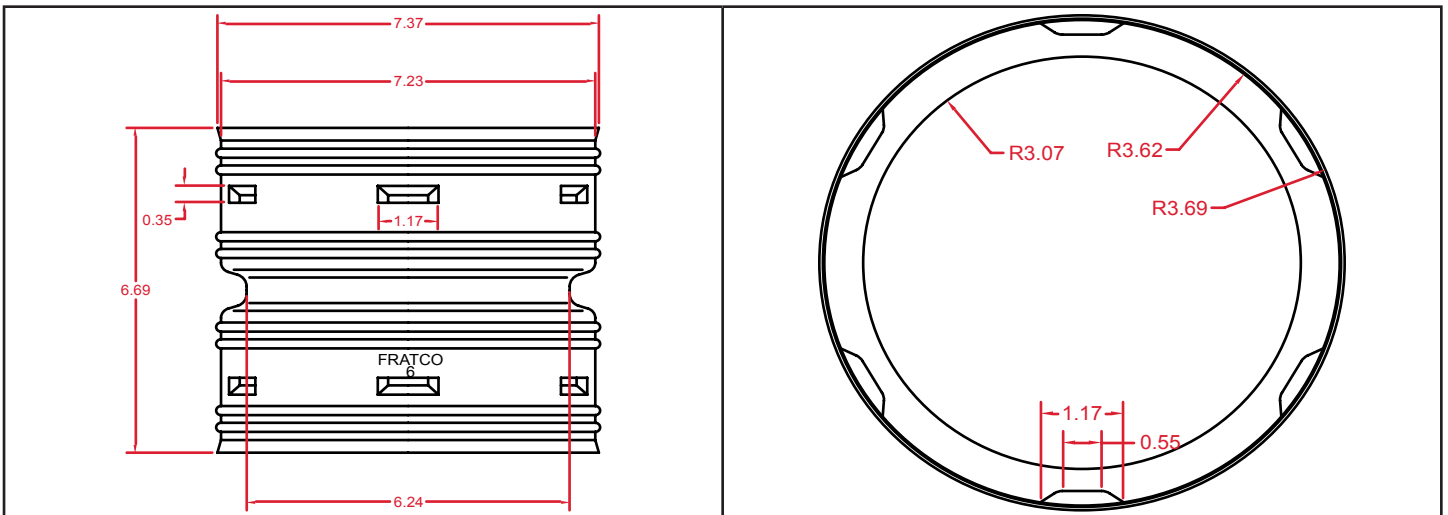

FITTING NUMBER	
40061200	
FITTING	SIZE
SNAP COUPLER	6"

MEASUREMENTS



PART WEIGHT
150 grams (+/- 15 grams)

PART WALL DISTRIBUTION
.07"

These specifications are held in standard according to ASTM F667 - Standard Specification for Polyethylene Plastics Pipe and Fittings material.