

FITTING NUMBER	
40088600	
FITTING	SIZE
REDUCER	8"x6"

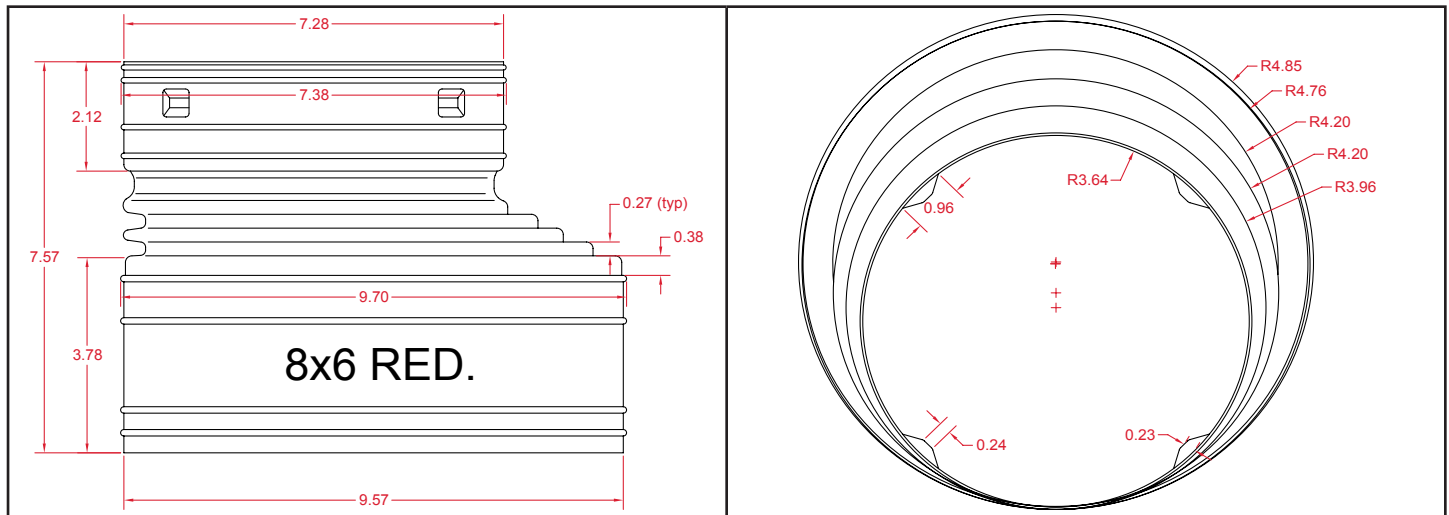

MEASUREMENTS



PART WEIGHT

230 grams (+/- 15 grams)

PART WALL DISTRIBUTION

.07"

These specifications are held in standard according to ASTM F667 - Standard Specification for Polyethylene Plastics Pipe and Fittings material.