

FITTING NUMBER

40082200

FITTING

BLIND TEE

SIZE

8"



MEASUREMENTS

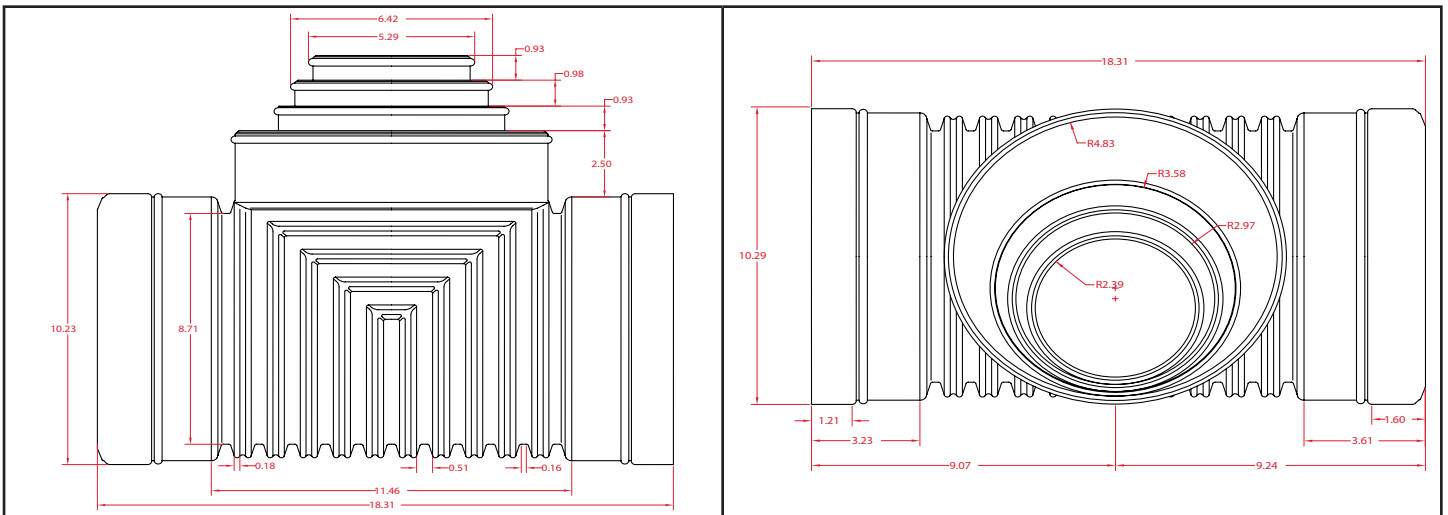

PART WEIGHT

1200 grams (+/- 30 grams)

PART WALL DISTRIBUTION

.082"

These specifications are held in standard according to ASTM F667 - Standard Specification for Polyethylene Plastics Pipe and Fittings material.