

FITTING NUMBER

40062200

FITTING

BLIND TEE

SIZE

6"



MEASUREMENTS

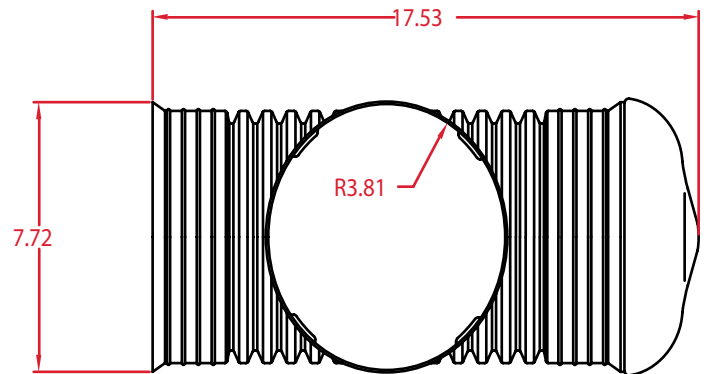
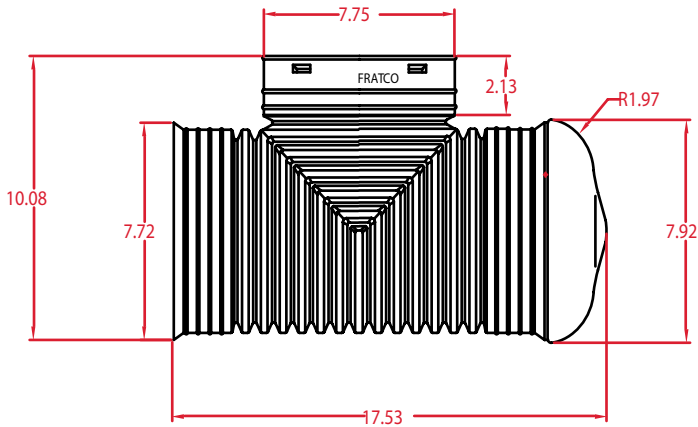

PART WEIGHT

675 grams (+/- 30 grams)

PART WALL DISTRIBUTION

.10"

These specifications are held in standard according to ASTM F667 - Standard Specification for Polyethylene Plastics Pipe and Fittings material.