

FITTING NUMBER	
40055000	
FITTING	SIZE
ADAPTER	5"

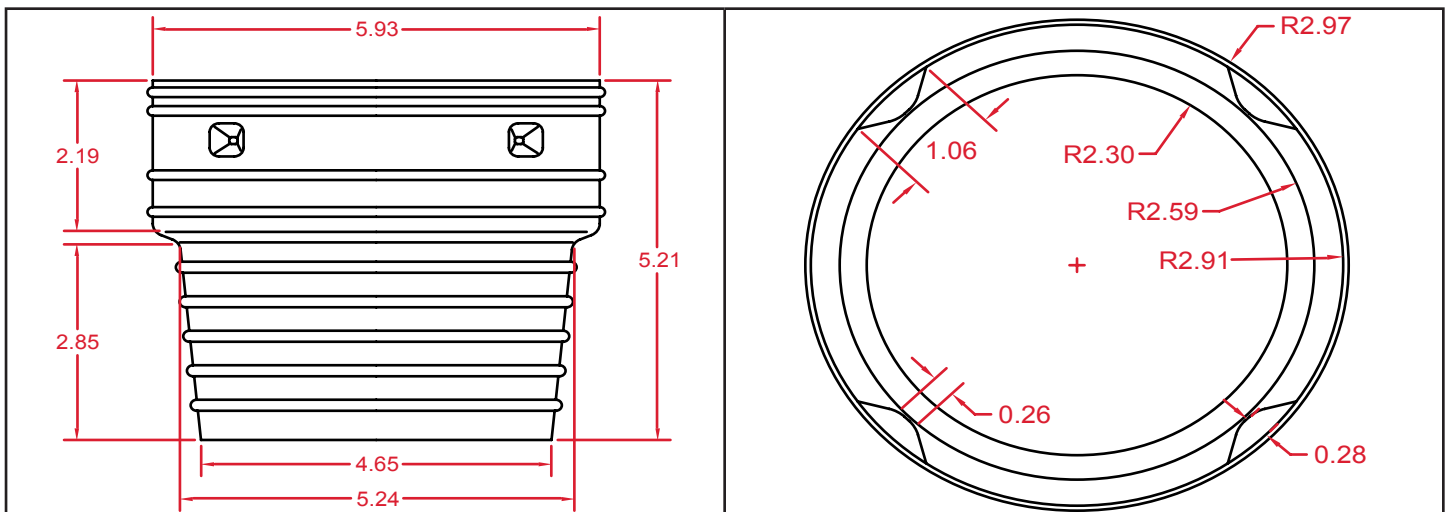

MEASUREMENTS



PART WEIGHT

100 grams (+/- 8 grams)

PART WALL DISTRIBUTION

.06"

These specifications are held in standard according to ASTM F667 - Standard Specification for Polyethylene Plastics Pipe and Fittings material.