

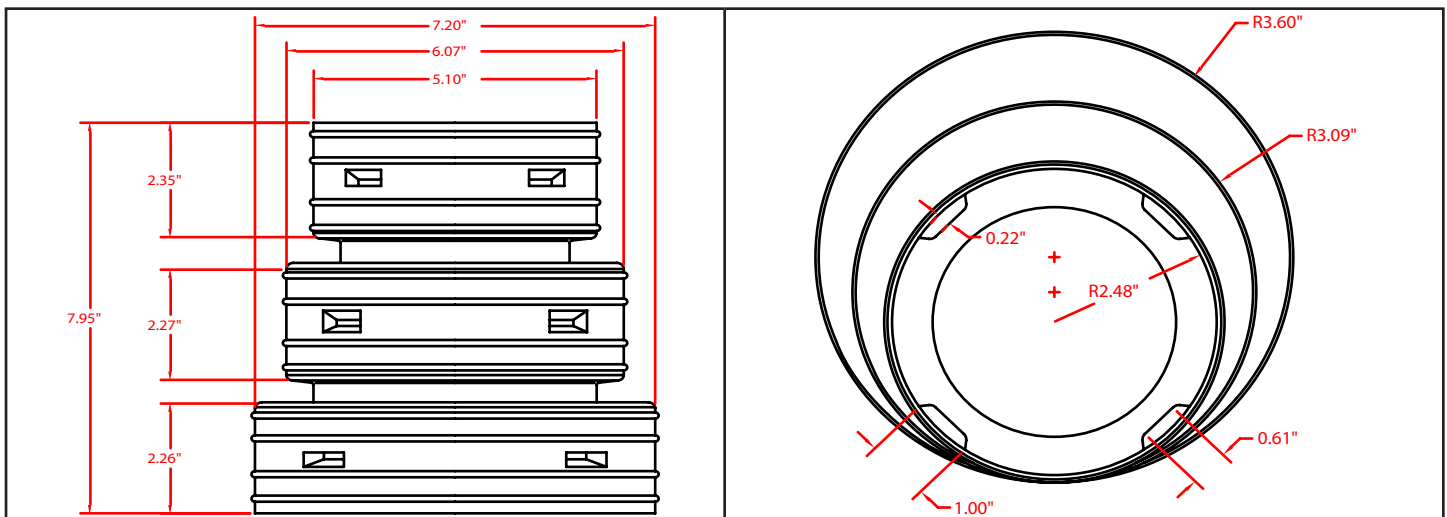

FITTING NUMBER	
40066540	
FITTING	SIZE
REDUCER	6"x5"x4"

MEASUREMENTS



PART WEIGHT

180 grams (+/- 15 grams)

PART WALL DISTRIBUTION

.06"

These specifications are held in standard according to ASTM F667 - Standard Specification for Polyethylene Plastics Pipe and Fittings material.